

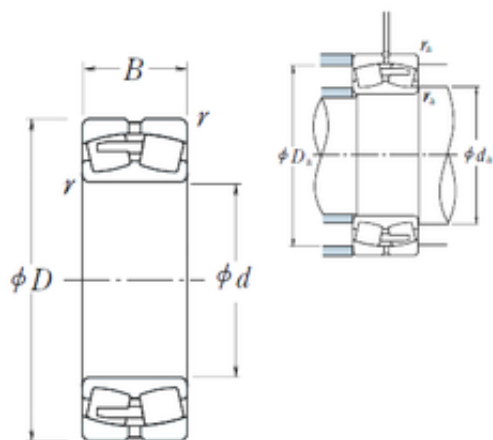

BEARING CORP.OF AMERICA



280 mm x 380 mm x 75 mm NSK 23956CAE4 Spherical Roller Bearing

Bearing No. 23956CAE4

Size	280x380x75 mm
Bore Diameter	280 mm
Outer Diameter	380 mm
Width	75 mm
d	280 mm
D	380 mm
B	75 mm
C	75 mm
r min.	2,1 mm
da min.	292 mm
Da min	351 mm
Da max.	368 mm
ra max.	2 mm
Weight	24,5 Kg
Basic dynamic load rating (C)	925 kN
Basic static load rating (C0)	1950 kN
(Grease) Lubrication Speed	800 r/min
(Oil) Lubrication Speed	950 r/min
Calculation factor (e)	0,18
Calculation factor (Y0)	3,8
Calculation factor (Y2)	5,7

23956CAE4 Bearing 2D drawings and 3D CAD models