

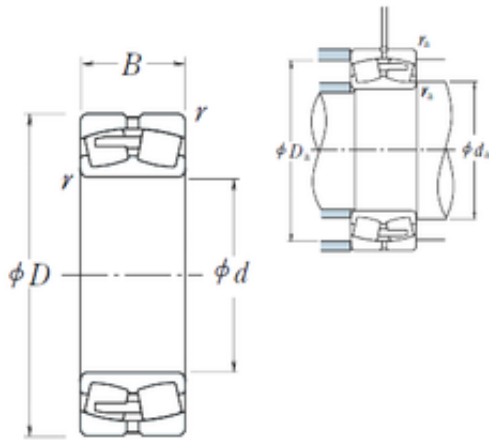

BEARING CORP.OF AMERICA



280 mm x 500 mm x 176 mm NSK 23256CAE4 Spherical Roller Bearing

Bearing No. 23256CAE4

23256CAE4 Bearing 2D drawings and 3D CAD models

Size	280x500x176 mm
Bore Diameter	280 mm
Outer Diameter	500 mm
Width	176 mm
d	280 mm
D	500 mm
B	176 mm
C	176 mm
r min.	5 mm
da min.	302 mm
Da min	425 mm
Da max.	478 mm
ra max.	4 mm
Weight	147 Kg
Basic dynamic load rating (C)	2880 kN
Basic static load rating (C0)	4900 kN
(Grease) Lubrication Speed	530 r/min
(Oil) Lubrication Speed	670 r/min
Calculation factor (e)	0,35
Calculation factor (Y0)	1,9
Calculation factor (Y2)	2,9