

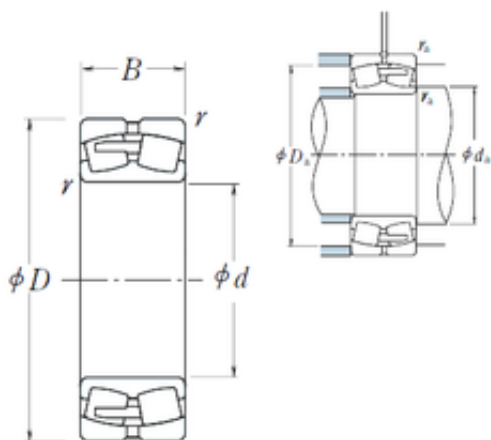

BEARING CORP.OF AMERICA

320 mm x 580 mm x 150 mm NSK 22264CAE4 Spherical Roller Bearing

Bearing No. 22264CAE4



22264CAE4 Bearing 2D drawings and 3D CAD models

Size	320x580x150 mm
Bore Diameter	320 mm
Outer Diameter	580 mm
Width	150 mm
d	320 mm
D	580 mm
B	150 mm
C	150 mm
r min.	5 mm
da min.	342 mm
Da min	508 mm
Da max.	558 mm
ra max.	4 mm
Weight	174 Kg
Basic dynamic load rating (C)	2990 kN
Basic static load rating (C0)	4850 kN
(Grease) Lubrication Speed	530 r/min
(Oil) Lubrication Speed	670 r/min
Calculation factor (e)	0,26
Calculation factor (Y0)	2,6
Calculation factor (Y2)	3,9