

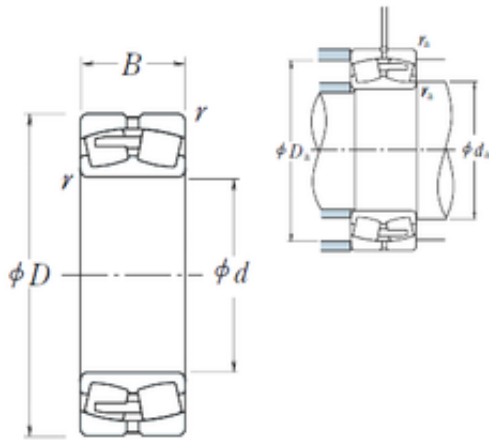

BEARING CORP.OF AMERICA



340 mm x 520 mm x 133 mm NSK 23068CAE4 Spherical Roller Bearing

Bearing No. 23068CAE4

23068CAE4 Bearing 2D drawings and 3D CAD models

Size	340x520x133 mm
Bore Diameter	340 mm
Outer Diameter	520 mm
Width	133 mm
d	340 mm
D	520 mm
B	133 mm
C	133 mm
r min.	5 mm
da min.	362 mm
Da min	465 mm
Da max.	498 mm
ra max.	4 mm
Weight	101 Kg
Basic dynamic load rating (C)	2280 kN
Basic static load rating (C0)	4400 kN
(Grease) Lubrication Speed	560 r/min
(Oil) Lubrication Speed	710 r/min
Calculation factor (e)	0,24
Calculation factor (Y0)	2,8
Calculation factor (Y2)	4,2