

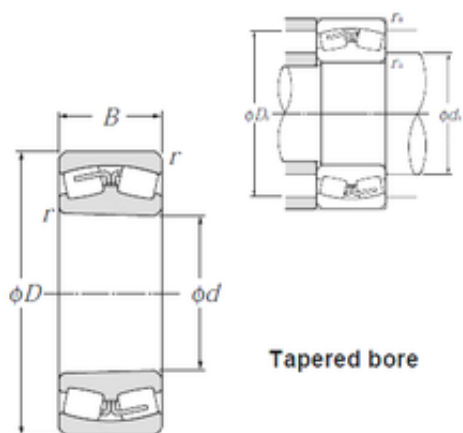

BEARING CORP.OF AMERICA

670 mm x 1 090 mm x 412 mm NTN 241/670BK30 Spherical Roller Bearings



Bearing No. 241/670BK30

Size	670x1090x412 mm
Bore Diameter	670 mm
Outer Diameter	1090 mm
Width	412 mm
d	670 mm
D	1 090 mm
B	412 mm
C	412 mm
r min.	7,5 mm
da min.	706 mm
Da max.	1 054 mm
ra max.	6 mm
Weight	1 510 Kg
Basic dynamic load rating (C)	12 700 kN
Basic static load rating (C0)	28 000 kN
(Grease) Lubrication Speed	230 r/min
(Oil) Lubrication Speed	300 r/min
Calculation factor (e)	0,37
Calculation factor (Y0)	1,79
Calculation factor (Y1)	1,83

241/670BK30 Bearing 2D drawings and 3D CAD models